

LOGOSOL

USER INSTRUCTIONS

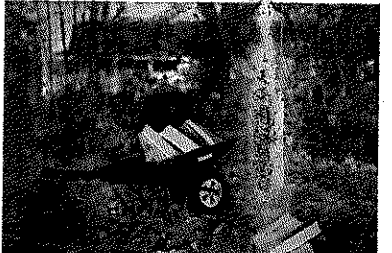

BRUKSANVISNING I ORIGINAL
USER INSTRUCTIONS IN ORIGINAL FORMAT
ARTIKELNR. / ARTICLE NO. 0458-395-2800

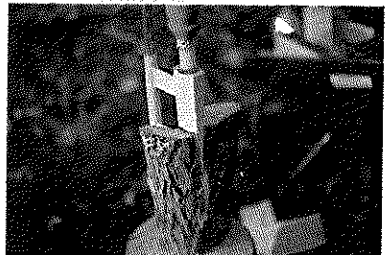
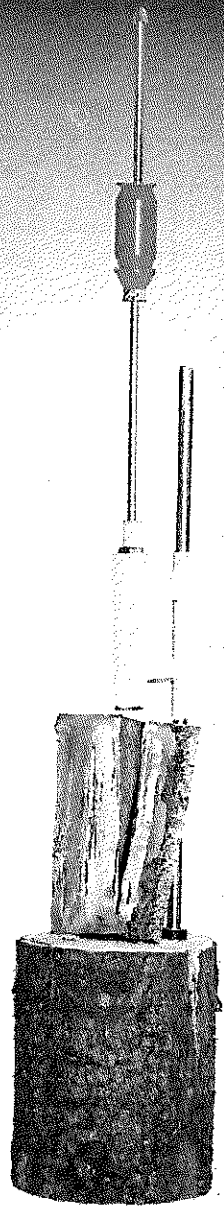

 **Smart-Splitter**[®]
A Smart-Line Product Patented

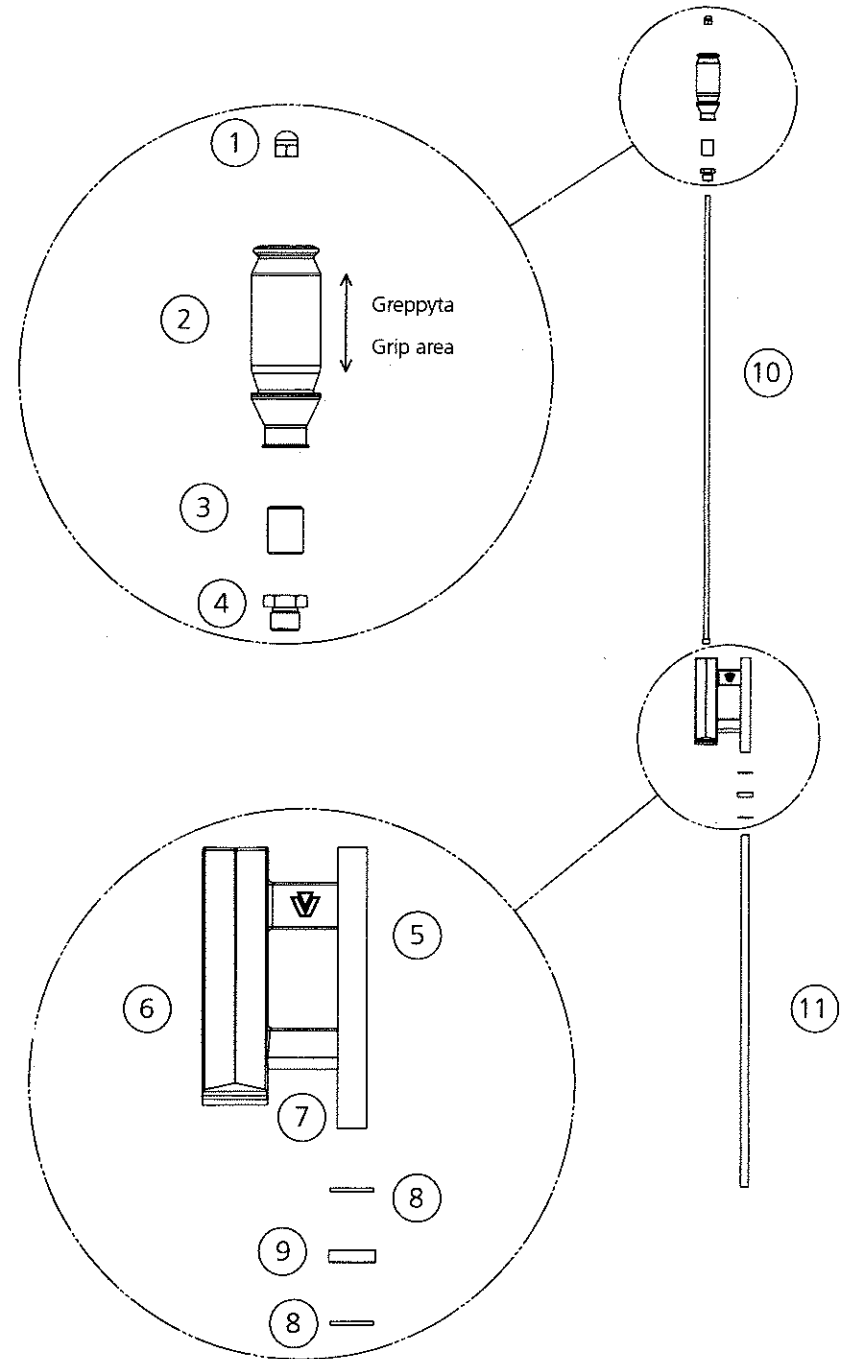

SMART-SPLITTER, KOMPONENTER



1	Stoppmutter	7	Spänkniv
2	Vikt	8	Guidebricka, stål
3	Plastbussning	9	Guidebricka, gummi
4	Yxmutter	10	Löpstång
5	Handtag	11	Guidestång
6	Yxa		











SMART-SPLITTER COMPONENTS



1	Stop nut	7	Splinter knife
2	Hammer	8	Guide washer, steel
3	Plastic bushing	9	Guide washer, rubber
4	Axe nut	10	Hammer guide rod
5	Handle	11	Axe guide rod
6	Axe		

SAFETY INSTRUCTIONS



-  Risk of cut and crush injuries.
 -  Use protective gloves when assembling and using the Smart-Splitter.
 -  The Smart-Splitter has two sharp edges, one on the lower part of the axe and one on the splinter knife. Only use the axe handle (see illustration on p.2) to lift the axe.
 -  Never hold the log when the hammer is lifted from the axe. You should always lift the hammer with both hands.
 -  Keep your hands within the machined markings on the hammer. Keep your fingers together. (See illustration on p.2 for allowed grip area on the hammer.)
 -  Always let go of the hammer when it is at least 20 cm above the axe.
 -  Risk of splinters springing off.
 -  Use safety goggles.
 -  Risk of exposure to loud noise.
 -  Use ear protection.
-  Persons using the Smart-Splitter must be over 16 years old and must have read and understood the user instructions. Ensure that no unauthorized person uses the Smart-Splitter. Lift off the axe from the guide rod when leaving the Smart-Splitter unattended.
 - Max. allowed wood length is 55 cm. Recommended wood length is 40 cm.
 - The Smart-Splitter should stand on a plane and stable surface.
 - The axe guide rod should fit firmly or tightly in its hole.
 - If the chopping block has to be moved, the axe must first be removed from the guide rod.
- Lifting instructions, axe:** Use protective gloves. Hold the axe guide rod with one hand, and the axe handle with your other hand. Turn the axe edge away from you.

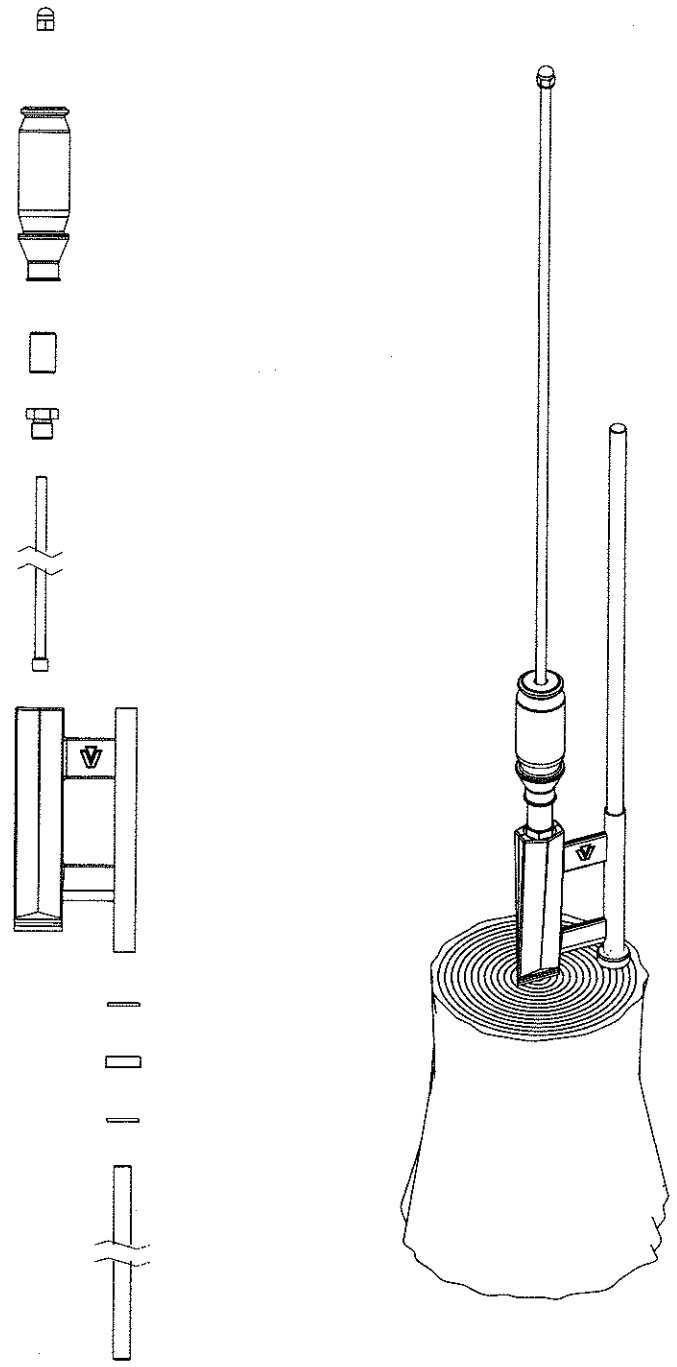

MONTERING

Använd en huggkubbe som är 35 cm hög och minst 35 cm i diameter.

1. Borra ett hål i huggkubben, diameter 20 mm, med den medföljande borren. Hålet ska vara 8 cm in från huggkubbens kant och 12 cm djupt.
2. Se till att yxmuttern, plastbussningen och vikten är påträdd på löpstången enligt fig. till vänster, och att stoppmuttrarna är korrekt monterade i löpstångens ändar.

3. Skruva in yxmuttern i yxan. Dra åt hårt.

4. För ned guidestången i det borrarade hålet i huggkubben och trä på guidebrickorna enl fig. till vänster.

TIPS: Kila fast guidestången i hålet så att den sitter fast.

5. Håll i löpstången och handtaget på yxdelen och trä på yxdelen på guidestången.

ASSEMBLY

Use a chopping block that is 35 cm in height and at least 35 cm in diameter.

1. In the chopping block, drill a hole with a diameter of 20 mm, using the supplied drill bit. The hole should be placed 8 cm in from the edge of the chopping block and be 12 cm deep.
2. Make sure that the axe nut, the plastic bushing and the hammer are fitted on the hammer guide rod according to the illustration to the left, and that the stop nut and axe nut are correctly fitted at the ends of the axe guide rod.

3. Screw the axe nut into the threaded hole in the axe. Tighten it firmly.

4. Fit the axe guide rod in the drilled hole in the chopping block and thread the guide washers onto the rod according to the illustration to the left.

TIP: Wedge the axe guide rod in the hole to secure it.

5. Hold the axe guide rod and the handle of the axe and slip the axe onto the rod.

USING THE SMART-SPLITTER

- Read the safety instructions and use required protective equipment.

WOOD SPLITTING*

- Lift the axe by its handle and place the log under the edge of the axe.
- Take hold of the hammer. Keep both your hands within the grip area on the thickest part of the hammer (see illustration on p.2).
- Lift the hammer and throw it down. Let the hammer go in good time before it hits the axe. If necessary, you repeat step 3 until the axe has split the log.

SPLITTING SPLINTERS

- Place the piece of wood under the splinter knife.
- Lift the hammer with both hands and throw the hammer down towards the axe.

DISLODGING THE AXE

If the axe stops in the log without splitting it, it can get stuck in the log.

- Take hold of the hammer with both hands.
- With both hands, strike the hammer against the stop nut on the guide rod until the axe come loose. **TIP:** If you cannot reach all the way up, turn the axe and the log 180 degrees to make the log fall down from the chopping block. This way, the hammer guide rod will be lowered too (see illustration below).

! IMPORTANT: The plastic bushing is a wear part that has to be replaced after a period of use. Never use the Smart-Splitter without a plastic bushing, since this will result in high noise and damage the axe.

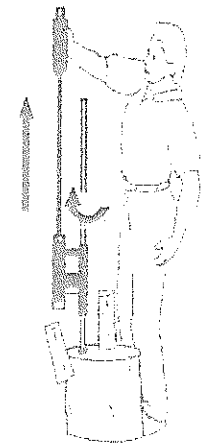

*See illustration on p.10.

1

